

MICRO RECESSED

E91141-

base number Color
Temperature

PROJECT	_____
TYPE	_____
SPECIFIER	_____
QUANTITY	_____
DATE	_____

- To build a product code in our configurator select the specify button on the base model # product page
- To build a manual product code on this datasheet choose from the options listed below in blue font and add the suffix to the base model #

GENERAL

Series: Micro
Brand: Platek
Division: Exterior
Mounting Type: Recessed
Mounting Location: In-Ground
Subcategory: Drive Over

PHYSICAL

Shape: Round
Diameter (mm): 95
Diameter (in): 3 3/4
Height (mm): 97
Height (in): 3 13/16
Light Distribution: Direct
Weight (kg): 0.55
Weight (lbs): 1.2
Load Resistance (kg): 2000
Load Resistance (lbs): 4409
Installation Requirement: Installation in sleeve set in concrete with a 20 - 30cm / 8 - 12" gravel drain bed
Diffuser: Clear tempered glass
Fixture Finish: SST
Fixture Material: Aluminum Die Cast
Cable Details: Supplied with 1 power cable 1m in length

ELECTRICAL

Lamp Type: LED
Input Wattage (W): 2.5
Total Output Wattage (W): 2
Driver Included: No
Driver Location: Remote
Driver Type: Constant Current - Universal
Driver Class: Class 2
Housing: (Not included - see components) L9A09600 allows for external driver (non-dimming - 120 / 277Vac [-25
Input Voltage (V): 120 - 277
Constant Current (MA): 700
Upon Request: External w/L9A09600 ONLY: Non-dimming 120 / 277Vac - min. operating temperature -25°C; if a lower operating temperature is required it must be REMOTE / (Not included - see components [IP65 or higher enclosure to be supplied by others]) Remote: (- 40°C) 0-10Vdc dimming (120 / 277Vac) / (-25°C) Phase dimming

LED

Number of LEDs: 1
Color Temperature (°K): 3000 / 4000
Max. Delivered Lumen (lm): 130 / 135
Nominal Lumen (lm): 250 / 260
CRI: >80 CRI
Lamp Life (hrs): 60000

OPTICAL

Optic°: Asymmetric
Beam Angle: 62

RATINGS AND CERTIFICATIONS

Certified By: Certified for North American Standards
IP rating: IP68
IK Rating: IK10
Ene Rating: E0, E1, E2, E3, E4, E5, E6, E7, E8, E9

Eng. Rating: E0, E1, E2, E3, E4, E5, E6, E7, E8, E9, T 1800-388-3382, F 416-247-9319, www.zaneen.com

Available for International specifications by adding 'INT' at the end of the existing Model #. For assistance on 'custom' specifications, contact zteam@zaneen.com. In a constant effort to supply the best product, we reserve the right to change specifications or materials without notice. The most recent specification sheets are found at zaneen.com



49mm 1 15/16"

95mm 3 3/4"

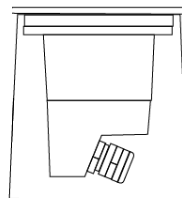
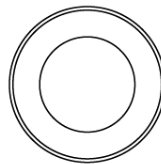

Slim Housing
L9A09500

49mm 1 15/16"

95mm 3 3/4"

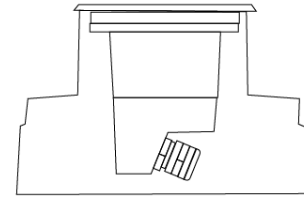
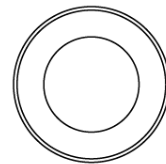

Wide Housing
L9A09600



MICRO RECESSED

E9I141-

PROJECT

TYPE

SPECIFIER

QUANTITY

DATE



MICRO RECESSED

E91157-

base number Color Lens
Temperature Options

- To build a product code in our configurator select the specify button on the base model # product page
- To build a manual product code on this datasheet choose from the options listed below in blue font and add the suffix to the base model #

GENERAL

Series: Micro
Brand: Platek
Division: Exterior
Mounting Type: Recessed
Mounting Location: In-Ground
Subcategory: Drive Over

PHYSICAL

Shape: Round
Diameter (mm): 95
Diameter (in): 3 3/4
Height (mm): 97
Height (in): 3 13/16
Light Distribution: Indirect
Weight (kg): 0.55
Weight (lbs): 1.2
Load Resistance (kg): 2000
Load Resistance (lbs): 4409
Installation Requirement: Installation in sleeve set in concrete with a 20 - 30cm / 8 - 12" gravel drain bed
Diffuser: Clear tempered glass
Fixture Finish: SST
Fixture Material: Aluminum Die Cast
Cable Details: Supplied with 1 power cable 0.5m in length

ELECTRICAL

Lamp Type: LED
Input Wattage (W): 5.9
Total Output Wattage (W): 5
Dimming: Non-Dimming / Phase Dimming (120Vac only) / 0-10V Dimming
Driver Included: No
Driver Location: Remote
Driver Type: Constant Current - 120/277Vac
Driver Class: Class 2
Input Voltage (V): 120 - 277
Constant Current (MA): 500

Upon Request: (Included) external w/L9A09600 only: Non-dimming 120 / 277Vac - min. operating temperature -25°C; if a lower operating temperature is required it must be REMOTE and is NOT included / (Not included - see components [IP65 or higher enclosure to be supplied by others]) Remote: (-40°C) 0-10Vdc dimming (120 / 277Vac) / (-40°C) Phase dimming @120Vac only

LED

Number of LEDs: 3
Color Temperature (°K): 3000 / 4000
Max. Delivered Lumen (lm): 435 - 465 / 450 - 485
Nominal Lumen (lm): 570 / 600
Lamp Life (hrs): 60000

OPTICAL

Optic°: 12 / 33 / 44

RATINGS AND CERTIFICATIONS

Certified By: Certified for North American Standards
IP rating: IP68
IK Rating: IK10
Bug Rating: B0 U3 G0

PROJECT	
TYPE	
SPECIFIER	
QUANTITY	
DATE	



Ø95mm 3 3/4"

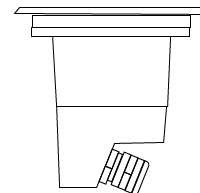
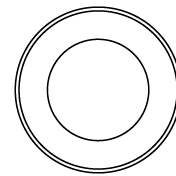

88mm 3 7/16"



MICRO RECESSED

E9I157-

PROJECT

TYPE

SPECIFIER

QUANTITY

DATE



MICRO RECESSED

E91564-

base number Color Lens
 Temperature Options

- To build a product code in our configurator select the specify button on the base model # product page
- To build a manual product code on this datasheet choose from the options listed below in blue font and add the suffix to the base model #

GENERAL

Series: Micro
 Brand: Platek
 Division: Exterior
 Mounting Type: Recessed
 Mounting Location: In-Ground
 Subcategory: Drive Over

PHYSICAL

Shape: Round
 Diameter (mm): 95
 Diameter (in): 3 3/4
 Height (mm): 88
 Height (in): 3 1/2
 Light Distribution: Uplight
 Weight (kg): 0.5
 Weight (lbs): 1.1
 Load Resistance (kg): 2000
 Load Resistance (lbs): 4409
 Installation Requirement: Installation in sleeve set in concrete with a 20 - 30cm / 8 - 12" gravel drain bed
 Screws: No visible screws
 Diffuser: Clear tempered glass
 Fixture Finish: SST
 Fixture Material: Stainless Steel AISI 316L
 Cable Details: Supplied with 1 power cable 5m in length

ELECTRICAL

Lamp Type: LED
 Input Wattage (W): 5.9 / RGBW 6
 Total Output Wattage (W): 5 / RGBW 6
 Driver Included: No
 Driver Location: Remote
 Driver Type: White LED - Constant Voltage - 120 / 277Vac RGBW - Constant Current - Universal
 Housing: (Not included - see components) L9A09600 allows for external driver (non-dimming - 120 / 277Vac [-30
 Input Voltage (V): 120 - 277
 Output Voltage (V): 24
 Upon Request: (Not included - see components [IP65 or higher enclosure to be supplied by others]) 0-10Vdc dimming / Phase dimming / Non-dimming 120/277Vac / DMX

LED

Number of LEDs: 3 / RGBW 4
 Color Temperature (°K): 3000 / 4000 / RGBW
 Max. Delivered Lumen (lm): 435 - 465 / 450 - 485
 Nominal Lumen (lm): 570 / 600
 CRI: >80 CRI
 Lamp Life (hrs): 60000

OPTICAL

Optic°: 12 / 33 / 44

RATINGS AND CERTIFICATIONS

Certified By: Certified for North American Standards
 IP rating: IP68
 IK Rating: IK10
 Bug Rating: B0 U3 G0
 Marine Grade: Stainless Steel AISI 316L

Zaneen Group Inc. © 2024, T 1800-388-3382, F 416-247-9319, www.zaneen.com

Available for International specifications by adding 'INT' at the end of the existing Model #. For assistance on 'custom' specifications, contact zteam@zaneen.com. In a constant effort to supply the best product, we reserve the right to change specifications or materials without notice. The most recent specification sheets are found at zaneen.com

PROJECT
TYPE
SPECIFIER
QUANTITY
DATE



49mm 1 15/16"

95mm 3 3/4"

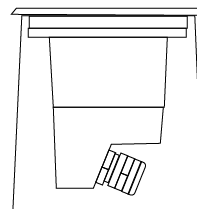
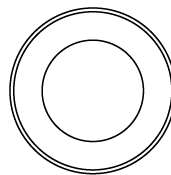

Slim Housing
L9A09500



49mm 1 15/16"

95mm 3 3/4"

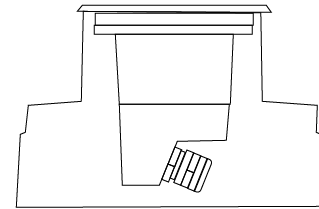
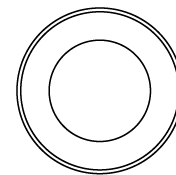

Wide Housing
L9A09500

MICRO RECESSED

E9I564-

PROJECT

TYPE

SPECIFIER

QUANTITY

DATE

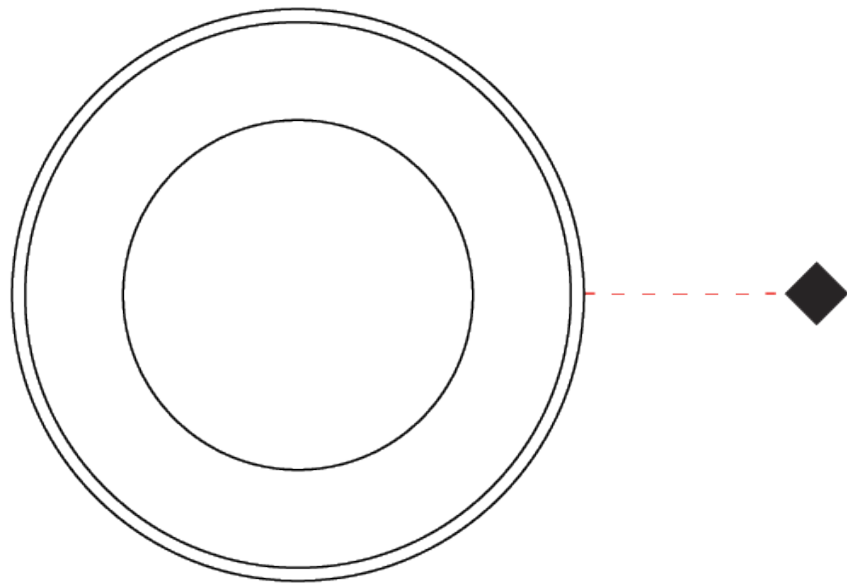

MICRO RECESSED

E91570-

base number Color Lens
 Temperature Options

- To build a product code in our configurator select the specify button on the base model # product page
- To build a manual product code on this datasheet choose from the options listed below in blue font and add the suffix to the base model #

GENERAL

Series: Micro
 Brand: Platek
 Division: Exterior
 Mounting Type: Recessed
 Mounting Location: In-Ground
 Subcategory: Drive Over

PHYSICAL

Shape: Round
 Diameter (mm): 95
 Diameter (in): 3 3/4
 Height (mm): 88
 Height (in): 3 1/2
 Light Distribution: Uplight
 Weight (kg): 0.5
 Weight (lbs): 1.1
 Load Resistance (kg): 2000
 Load Resistance (lbs): 4409
 Installation Requirement: Installation in sleeve set in concrete with a 20 - 30cm / 8 - 12" gravel drain bed
 Screws: No visible screws
 Diffuser: Clear tempered glass
 Fixture Finish: SST
 Fixture Material: Stainless Steel AISI 316L
 Cable Details: Supplied with 1 power cable 0.5m in length

ELECTRICAL

Lamp Type: LED
 Input Wattage (W): 5.9
 Total Output Wattage (W): 5
 Driver Included: No
 Driver Location: Remote
 Driver Type: Constant Voltage - Universal
 Driver Class: Class 2
 Housing: (Not included - see components) L9A09600 allows for external driver (non-dimming - 120 / 277Vac - [-
 Input Voltage (V): 120 - 277
 Output Voltage (V): 24
 Upon Request: (Included) Integral w/L9A09600 ONLY - Non-dimming 120 / 277Vac / (Not included - see components [IP65 or higher enclosure to be supplied by others]) Remote: 0-10Vdc dimming / Phase dimming @120Vac only

LED

Number of LEDs: 3
 Color Temperature (°K): 3000 / 4000
 Max. Delivered Lumen (lm): 440 - 465 / 450 - 485
 Nominal Lumen (lm): 570 / 600
 CRI: >80 CRI
 Lamp Life (hrs): 60000

OPTICAL

Optic°: 12 / 33 / 44

RATINGS AND CERTIFICATIONS

Certified By: Certified for North American Standards
 IP rating: IP68
 IK Rating: IK10
 Bug Rating: B0 U3 G0

7440 Pine Grove, Stainless Steel, ASP316 © 2024, T 1900 380 2853, F 416-247-9319, www.zaneen.com

Available for International specifications by adding 'INT' at the end of the existing Model #. For assistance on 'custom' specifications, contact zteam@zaneen.com. In a constant effort to supply the best product, we reserve the right to change specifications or materials without notice. The most recent specification sheets are found at zaneen.com

PROJECT
TYPE
SPECIFIER
QUANTITY
DATE

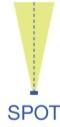

49mm 1 15/16"

49mm 1 15/16"

95mm 3 3/4"

95mm 3 3/4"

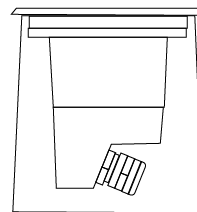
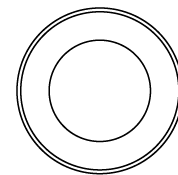
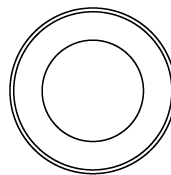

88mm 3 7/16"

97mm 3 13/16"

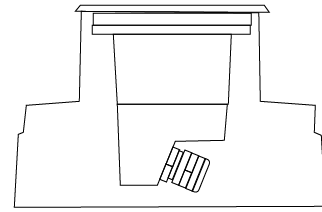

88mm 3 7/16"

97mm 3 13/16"

Slim Housing
L9A09500

Wide Housing
L9A09500



MICRO RECESSED

E9I570-

PROJECT

TYPE

SPECIFIER

QUANTITY

DATE

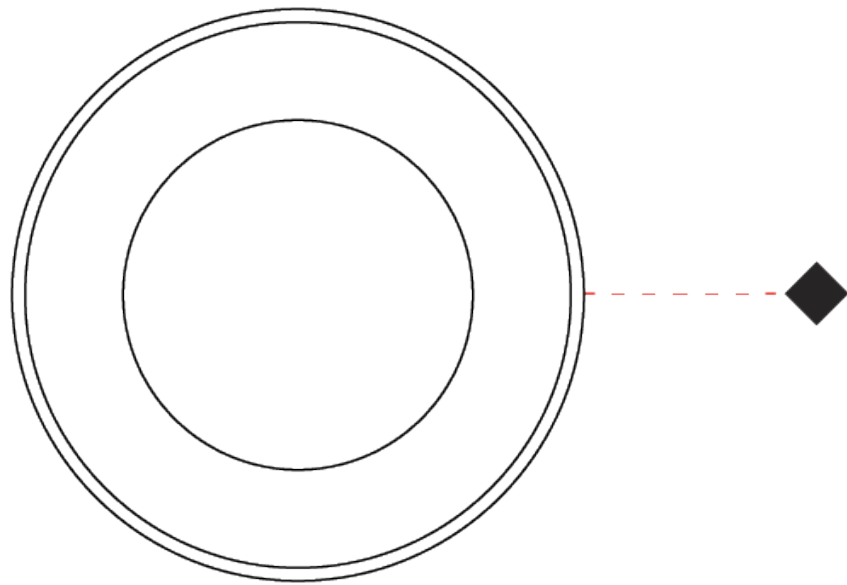

PROJECT	_____
TYPE	_____
SPECIFIER	_____
QUANTITY	_____
DATE	_____

Fixture Finish

Stainless Steel Inox - SST



Digital: Not all screens are calibrated the same, and therefore, colors will appear differently between screens.
Physical: When texture is involved, there will be variations in color, character and tone within a product series and between product families.



LEGEND

	floor-mounted		pivotal		special LED (upon request) RGB, RGBW, tunable, gold+, meat+, art+, fashion+
	wall and ceiling: recessed and surface mounted		rotating		warm dim / natural dimming LED
	ceiling-mounted and wall-mounted		illuminate tilted		rechargeable battery powered
	wall-mounted		color of suspension cable		fixture with natural vivid LED (upon request)
	omni-directional light distribution		length of suspension cable		color rendering index
	direct light distribution		reflector degree selection		color temperature
	direct/indirect light distribution		super spot		lumen (luminous flux)
	indirect light distribution		lens		efficacy (lumens per watt)
	asymmetric light distribution		lens pack		Unified Glare Rating (UGR) range from 5-40
	aura light distribution		shine ring		marine grade (AISI 316 stainless steel)
	round wall or ceiling cut-out		integrated shine ring with diffuser		walk on
	square wall or ceiling cut-out		free individual colors 01-29		drive on
	the supplied jig specifies the cutout dimensions		individual colors: 00 (free of charge), 01-25 (extra charge)		Dark Sky Compliance
	minimum distance (meters) lamp - object		luminaire part to be colored (F1)		Americans with Disabilities Act (less than 4" off the wall located between 27"-84" from floor)
	recessed depth		luminaire part to be colored (F2)		lamp protected against explosion
	ceiling thickness in mm		luminaire part to be colored (F3)		blown glass using traditional methods by master glass blower
	ceiling thickness selection		luminaire part to be colored (F4)		acoustic material
	dimmable DP (phase), DV (0-10V), DD (dali), DS (step-dim)		luminaire part to be colored (F5)		protection class I, protection insulation
	included or excluded LED driver/transformer/control gear		color of 3-circuit adaptor		protection class II, protection insulation
	separately switchable		indirect diffuser		ETL Certified to UL and CSA Standards
	sensor		direct diffuser		UL Certified to UL and CSA Standards
	remote control		ball-proof (upon request)		CSA Certified to UL and CSA Standards
	available upon request		accessory		Certified for North American Standards

IP RATING

	protected against ingress of solid bodies greater than 12.5mm (finger)
	protected against ingress of solid bodies greater than 2.5mm protected against sprays of water up to 60 degrees from the vertical (rain)
	protected against ingress of solid bodies greater than 1mm (wire) no protection against the ingress of moisture
	protected against ingress of solid bodies greater than 1mm (wire) protected against sprays of water up to 60 degrees from the vertical (rain)
	protected against ingress of solid bodies greater than 1mm (wire) protected against water splashed from all directions
	protected against limited ingress of dust (wet rooms/covered outdoor areas) protected against water splashed from all directions
	protected against ingress of dust protected against jets of water
	protected against ingress of dust protected against powerful jets of water or heavy seas
	protected against ingress of dust protected against immersion of water between 15cm - 1m for 30 minutes
	protected against ingress of dust protected against immersion of water under pressure for long periods

IK RATING

	protected against 0.14 joules impact (equivalent to 0.25kg mass dropped from 56mm above the surface)
	protected against 0.2 joules impact (equivalent to 0.25kg mass dropped from 80mm above the surface)
	protected against 0.35 joules impact (equivalent to 0.25kg mass dropped from 140mm above the surface)
	protected against 0.5 joules impact (equivalent to 0.25kg mass dropped from 200mm above the surface)
	protected against 0.7 joules impact (equivalent to 0.25kg mass dropped from 280mm above the surface)
	protected against 1 joules impact (equivalent to 0.25kg mass dropped from 400mm above the surface)
	protected against 2 joules impact (equivalent to 0.5kg mass dropped from 400mm above the surface)
	protected against 5 joules impact (equivalent to 1.7kg mass dropped from 300mm above the surface)
	protected against 10 joules impact (equivalent to 5.0kg mass dropped from 200mm above the surface)
	protected against 20 joules impact (equivalent to 5.0kg mass dropped from 400mm above the surface)